



中國·國望集團
國望科技(浙江)有限公司
CHINA·GUOWANG GROUP
GUOWANG TECHNOLOGY (ZHEJIANG) CO., LTD

浙江省平阳县万全轻工机械园区
Wanquan Light Industry Machinery Park,
Pingyang Country, Zhejiang Province
T +86-577-58111111 F +86-577-58111077
E master@guowang.com

WWW.GUOWANG.COM

SHANGHAI EUREKA
MACHINERY IMP.& EXP.CO.,LTD

Room 17011727 Fourune Times Manison No.1438
Shanxi Rd(n) Shanghai P.r.china
T +86-21-62998061 62986517 62999507 F +86-21-62985160
E Info@eureka-machinery.com

WWW.EUREKA-MACHINERY.COM



HOT STAMPING MACHINE 自动烫金&模切-C/R 系列

KEEP IMPROVING TO WIN MORE EXPECTATION

不斷超越，才能贏得更多期待

中國·國望集團始創于1993年，是一家集研發、設計、生產、銷售、服務為一體的中國印後設備專業製造商。經30多年發展積累，現有占地面積近12萬平方，建築面積超20萬平方的現代化標準工廠。并在全球設有銷售、售後服務網點。準時為客戶提供優質快捷的售前售後服務。

不斷超越，才能贏得更多期待。公司按照國際頂尖企業的標準及架構，執行7S現場管理模式。公司引進50多臺國際先進的大型加工中心，有日本三菱、東芝、馬扎克、大隈、瑞士斯達拉格、意大利帕瑪、曼德利等高精度加工設備，同時引進瑞士海克斯康三坐標檢測儀，祇因對產品精度和品質的執著追求，強大的加工集群是您設備品質的堅定保證。

國望集團通過ISO9001質量管理體系認證，主要產品均已通過歐盟CE以及德國TUV認證，匯集全球優勢資源，融合國際前沿技術，精益求精全力打造新一代印後設備，以智能化、高精度、高效率、高品質的要求，重新定義印後裝備價值，賦予用戶強大的市場競爭力，為客戶創造最大利益。

國望產品包括：全自動燙金機、模切機、卷筒分切機、切紙機、取紙機、卸紙機、升降機、闌紙機等高品質印後設備。

Guowang's products include high-quality post-printing equipment such as fully Automatic hot stamping machines, Die-cutting machines, Roll slitters, Paper cutters, Paper loader, Paper unloader, Lifting machine, and Jogger.

The Guowang Group, founded in 1993, is a professional manufacturer of post-press equipment in China that integrates research and development, design, production, sales, and services. After more than 30 years of development, it now has a modern standard factory with an area of nearly 120,000 square meters and a construction area of over 200,000 square meters. And has sales and after-sales service outlets worldwide, providing customers with high-quality and efficient pre-sales and after-sales services on time.

Only by constantly surpassing to win more expectations. The company implements the 7S on-site management mode according to the standards and framework of top international companies. It has introduced more than 50 international advanced large-scale machining centers, including high-precision machining equipment such as Mitsubishi, Toshiba, Mazak, Okuma, Staubli, PAMA, and Mandelli from Japan, Switzerland, and Italy. At the same time, the company has introduced the Swiss Hexagon three-coordinate measuring instrument. With its persistent pursuit of product precision and quality, the strong machining cluster is a firm guarantee for your equipment quality.

The Guowang Group has obtained ISO9001 quality management system certification, and its main products have passed the EU CE and German TUV certification. The company gathers global advantageous resources, integrates international cutting-edge technology, and strives to create a new generation of post-press equipment with intelligent, high-precision, high-efficiency, and high-quality requirements. It redefines the value of post-press equipment and gives users strong market competitiveness, creating maximum benefits for customers.



R 130Y
Automatic hot stamping machine
全自動模切燙金機

03-04P

R 130 Q R 130
Automatic die-cutting machine with stripping
自動清廢模切機

05-06P

C 106 DH C 106 DHQ
Automatic die-cutting machine
自動重壓熱模切機

07-08P

C 106DY C 106Y / C 80 Y
Automatic hot stamping machine
自動重壓燙金、模切機

09-10P

C 106 Q C 106 / C 80 Q / C 80
Automatic die-cutting machine with stripping
清廢自動模切機

13-16P



PURSUIING GERMAN AND JAPANESE QUALITY
TO SHAPE A NATIONAL BRAND.
追求德日品質 塑造民族品牌

R 130 Y

Automatic hot stamping machine

全自動模切燙金機

燙金實則是印刷藝術中對美的追求。它是關注極致細節的質量突出。當您期望獲得最高的燙金質量與效果時，我們的燙金設備是您當之無愧的首選。它最多可裝配六根縱向送箔軸（具備防偽功能）和兩根送箔軸，可供您根據產品的需求進行任意選擇。操控系統配兩個19寸和一個10.4寸觸摸屏控制系統，在觸摸屏導航設置功能中可對紙張印刷圖案的套準進行任意精確調整。在勻步式和跳步式的燙印過程中，電化鋁箔的間距可最小調至2mm，從而使您有效的節約成本和提高效率。機械部位經過國際專業工程師的重新設計，使燙印運轉過程中可達到450噸的壓力，使得燙印、凹凸呈現出更加立體的效果，同時也保證更高的燙印速度。

Hot stamping is actually the pursuit of beauty in the art of printing. It focuses on the quality of extreme detail. When you expect the highest quality and effect of hot stamping, our hot stamping equipment is your well-deserved first choice. It can be equipped with up to six vertical foil feeding shafts (with anti-counterfeiting function) and two foil feeding shafts, which can be selected according to the product's needs. The control system is equipped with two 19-inch and one 10.4-inch touch screen control systems. In the touch screen navigation setting function, the register of the paper printing pattern can be adjusted precisely as needed. In the continuous and intermittent hot stamping process, the spacing of the electro-aluminum foil can be adjusted to a minimum of 2mm, which effectively saves costs and improves efficiency. The mechanical parts have been redesigned by international professional engineers, which enables the hot stamping operation to achieve a pressure of up to 450 tons, resulting in a more three-dimensional effect of hot stamping and embossing, while also ensuring a higher hot stamping speed.

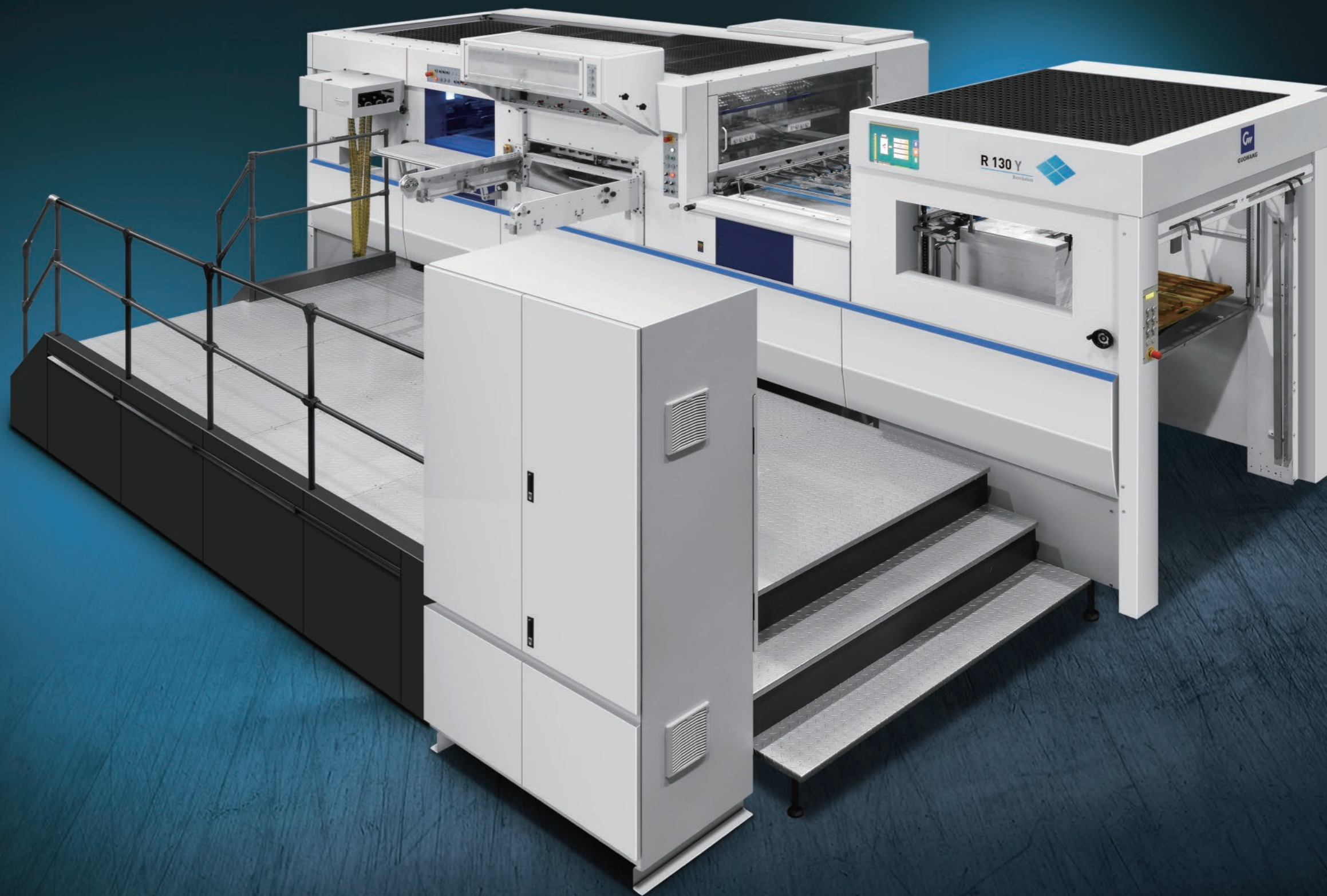

R 130 Q / R 130

Automatic die-cutting machine with stripping

自動清廢模切機

該機主要用于印刷包裝工業中的紙盒、紙箱、商標的模切、壓痕和冷壓凹凸等，特別是各種高級精細的印刷品，如煙盒、酒盒、禮品盒、小家電盒、化妝品盒等，均可以在本機上進行以及凹凸壓痕，以獲得富于立體感、精緻美觀的印刷制品。

This machine is mainly used for die-cutting, creasing and cold pressing of paper boxes, cartons and trademarks in the printing and packaging industry, especially for various high-level and fine prints, such as cigarette boxes, wine boxes, gift boxes, and small household appliances boxes. , Cosmetic boxes, etc., can be performed on this machine as well as concave-convex indentation to obtain three-dimensional, exquisite and beautiful printed products.

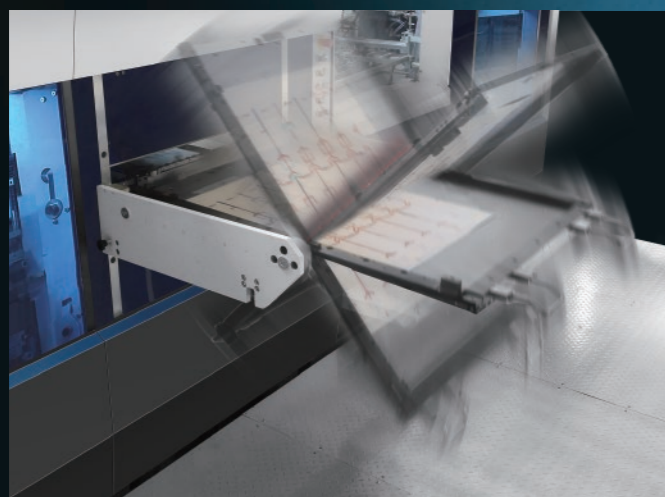
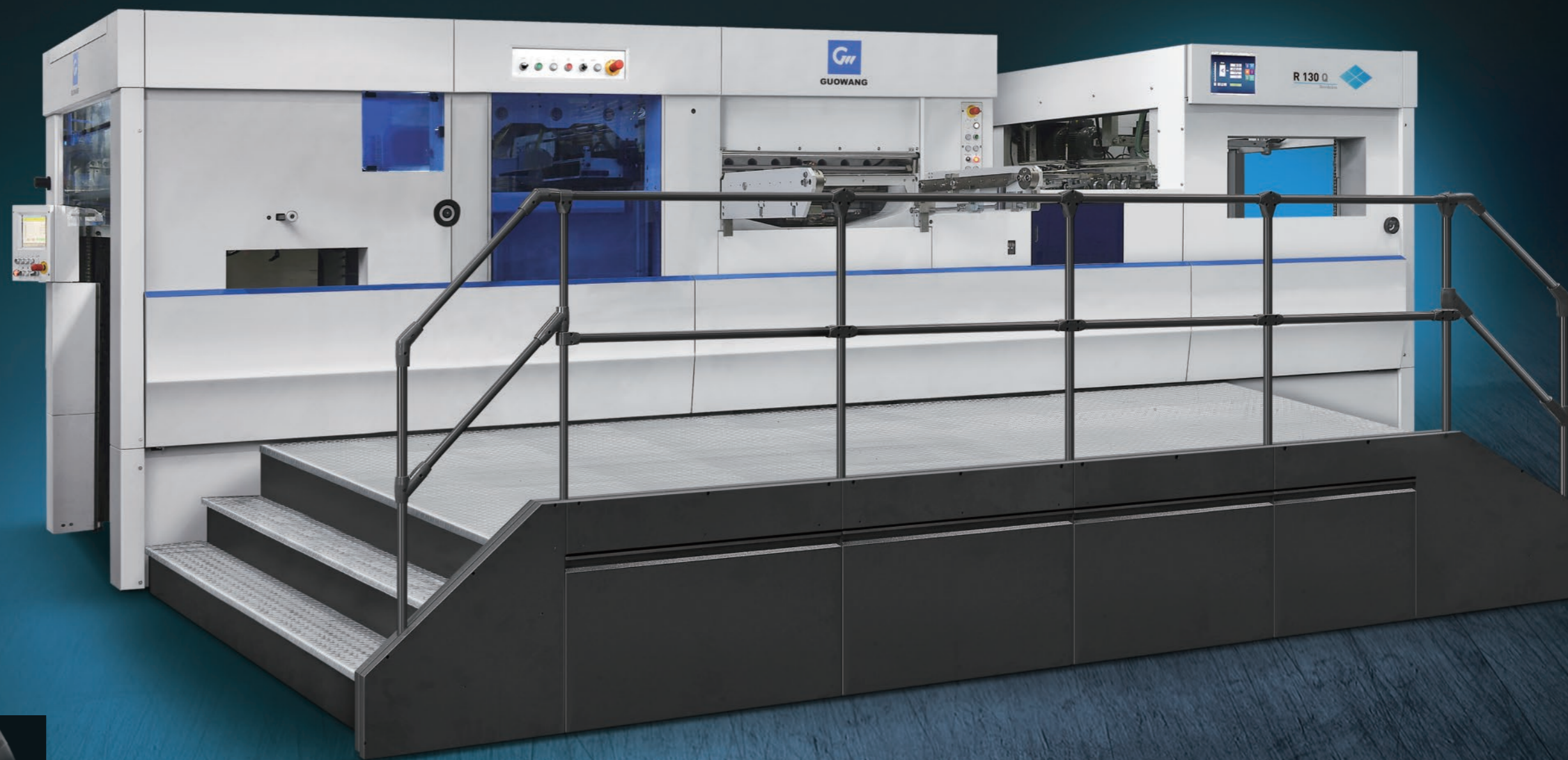

C 106 DH / C 106DHQ

Automatic die-cutting machine

自動重壓熱模切機

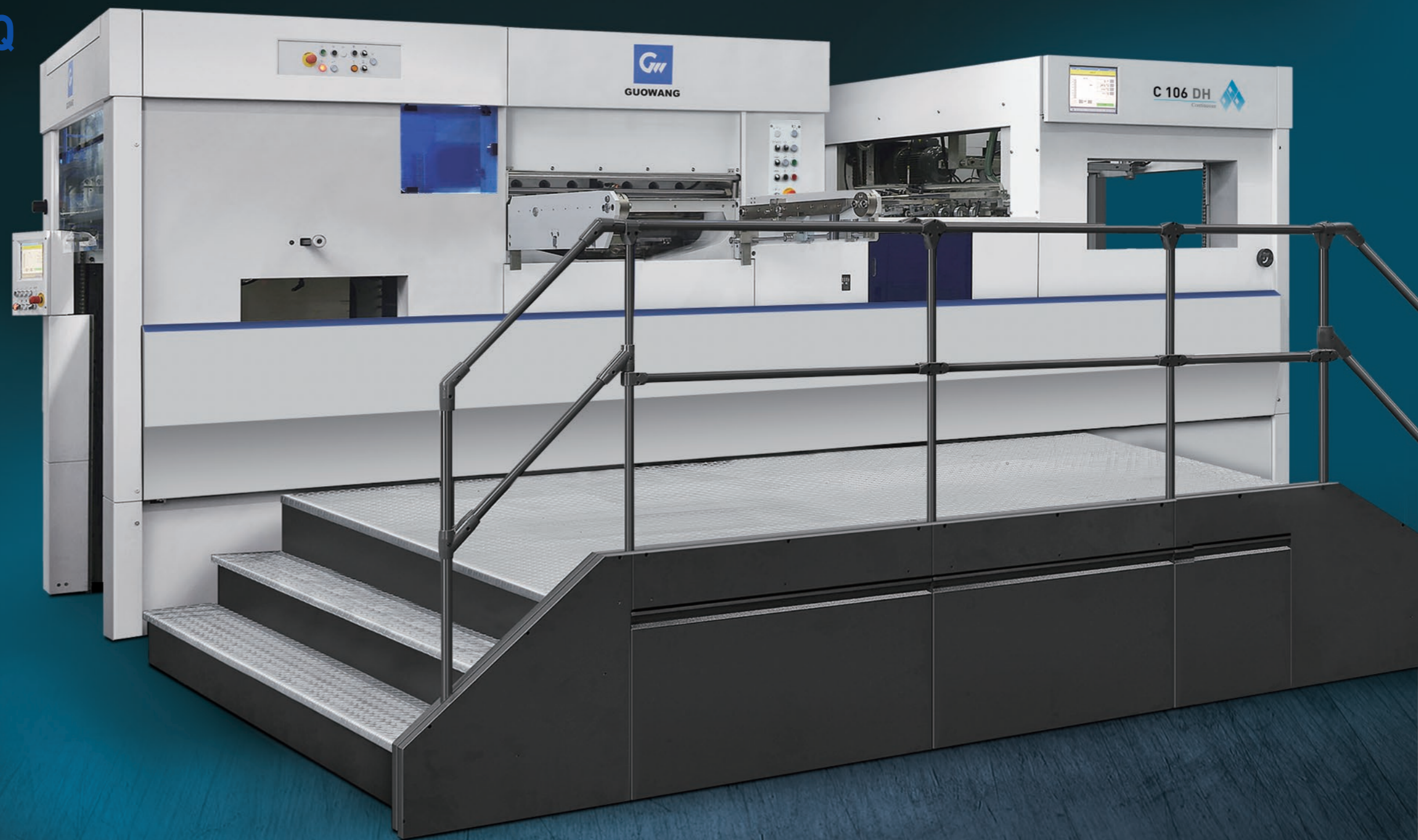

該機主要用于印刷包裝工業中的紙盒、彩箱、商標、深壓紋和冷壓或熱壓凹凸模切等功能，特別是各種高級精細的印刷品，如煙盒、酒盒、禮品盒、化妝品盒、PET、PVC、PP透明膠盒、拼圖等，均可以在本機上進行模切凹凸壓紋，更豐富立體感，精致美觀的印刷制品。

The machine is mainly used in printing and packaging industry in cartons, color box, trademark, deep embossing and cold or hot pressing is concave and convex die cutting, and other functions, especially all kinds of advanced fine print, such as cigarette case, wine box, gift boxes, cosmetics boxes, PET, PVC, PP box, puzzles, etc., can be conducted on this machine die-cutting concave-convex embossing, more have stereo feeling, elegant and beautiful printing



C 106 DY / C 106 Y / C 80 Y

Automatic hot stamping machine

自動重壓燙金、模切機

燙金實則是印刷藝術中對美的追求。它是關注極致細節的質量突出。當您期望獲得最高的燙金質量與效果時，我們的燙金設備是您當之無愧的首選。它最多可裝配六縱向軸送箔和六軸全息防偽和二個橫向送箔軸，可供您根據產品的需求進行任意選擇。操控系統配有19、15、10.4寸LED三屏兼容觸摸屏控制系統，在勻步式和跳步式的燙印過程中，電化鋁箔的間距可最小調至2mm，從而使您有效的節約成本和提高效率。

Hot stamping is actually the pursuit of beauty in the art of printing. It is outstanding quality with attention to extreme details. When you expect the highest bronzing quality and effect, our bronzing equipment is your well-deserved first choice. It can be equipped with up to six vertical, six interest (anti-counterfeiting), and two horizontal, which can be selected according to the needs of the product. The control system is equipped with a 19, 15, and 10.4 inch LED three-screen compatible touch screen control system. During the stepping and skipping hot stamping process, the pitch of the electrochemical aluminum foil can be adjusted to a minimum of 2mm, so that you can effectively save costs and improve efficiency.

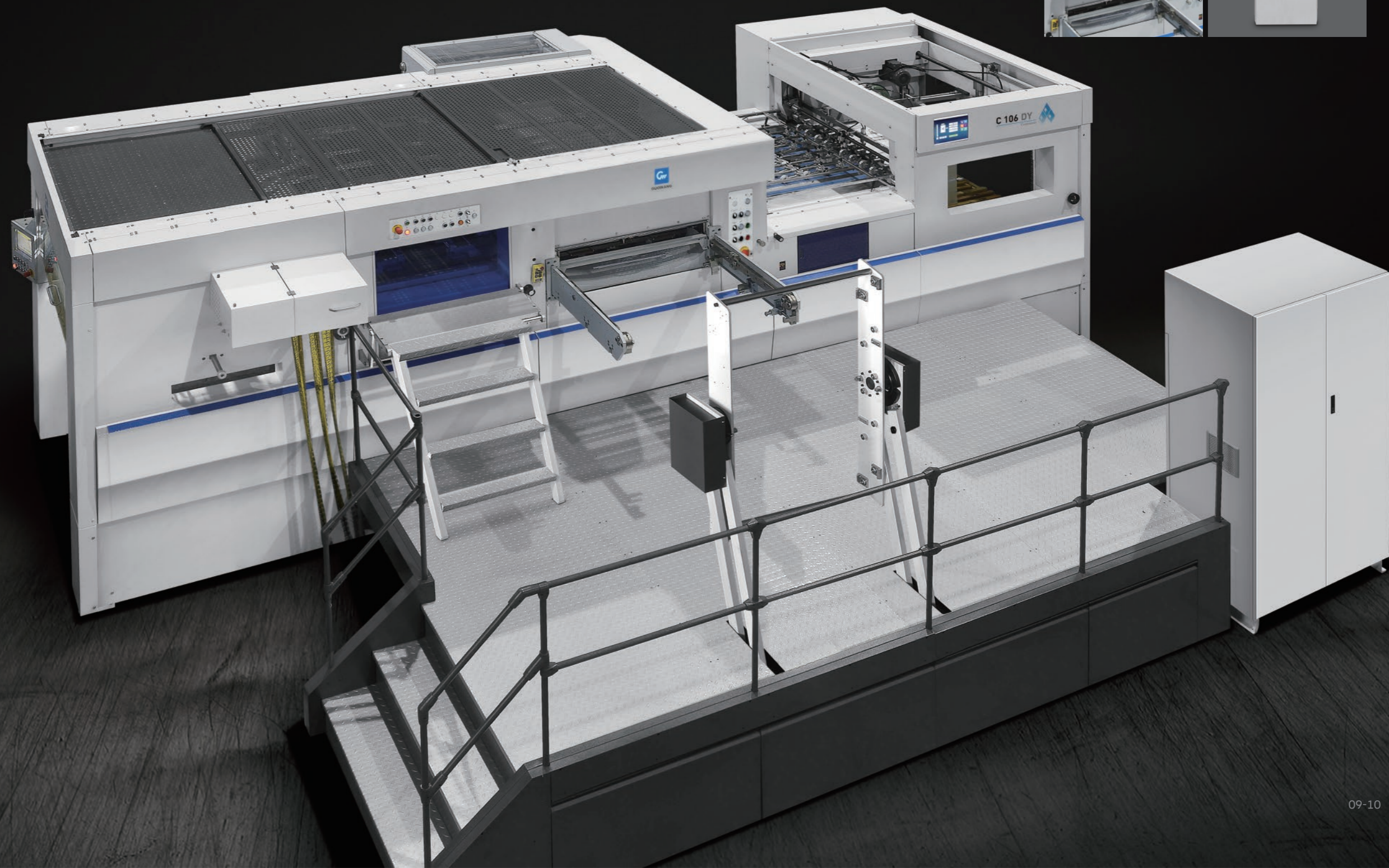

可選配 OPTIONAL:

橫向燙金最多可選配兩橫燙金
Transversal foil-stamping can optional
equip maximum 2 transversal
bronzing shafts

自動收箔機WFR-280配有10.4寸
LED觸摸屏自動6軸伺服收箔機
Equipped with 10.4 Inch Touch
Screen Automatic 6 Axis Servo
Foil Coll Ecting Machine



安裝地基圖
INSTALLATION FLOOR PLAN

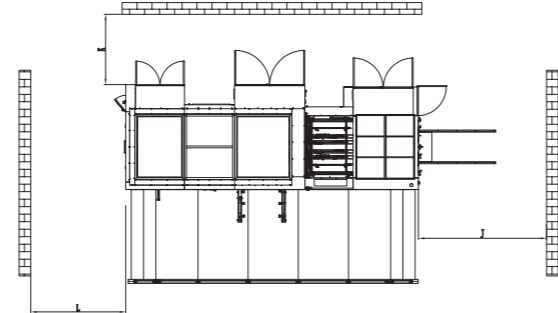
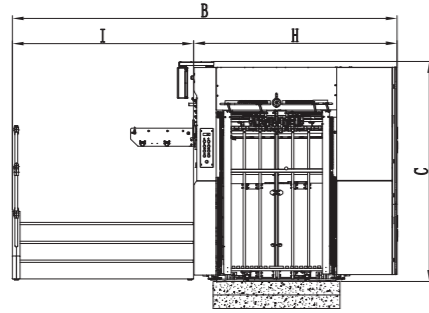
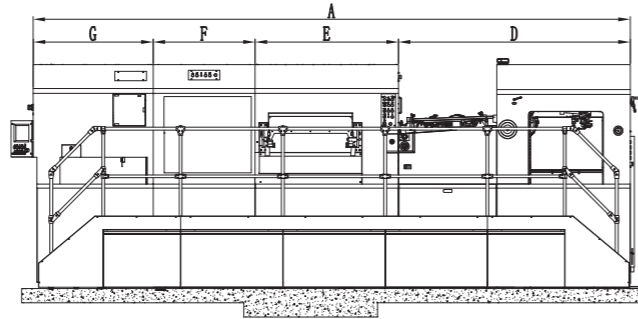

機器參數	SPECIFICATIONS						
型號	Model	C 80 Y	C 106 Y	C 106 DY	C 106 DH	C 106 DHQ	R 130 Y
最大用紙幅面	Max. sheet size	mm 800x600	1060x760	1060x760	1060x760	1060x760	1300x950
最小用紙幅面	Min. sheet size	mm 300x260	450x370	450x370	360x360	360x360	550x450
最大裁切幅面	Max. die-cutting size	mm 785x585	1045x745	1045x745	1045x745	1045x745	1285x935
最大燙金幅面	Max. stamping size	mm 760x580	1040x740	1045x740	\	\	1260x920
模切版框內尺寸	Die size	mm 840x620	1100x770	1100x770	1100x770	1100x770	\
模切鋼板	Cutting plate	mm 3-1	3-1	3-1	3-1	3-1	4-1
鋼線的高度(模切刀)	Height of die-cutting rule	mm 23.8	23.8	23.8	23.8	23.8	23.8
刀模第一把刀線	First cutting rule	mm 13	13	13	13	13	13
牙片咬口大小	Gripper margin	mm 9-17	9-17	9-17	9-17	9-17	9-17
白卡紙規格	Carton board	g/m ² 90-2000	90-2000	90-2000	90-2000	90-2000	90-2000
卡紙規格	Carton board	mm 0.1-3	0.1-3	0.1-3	0.1-3	0.1-3	0.1-3
瓦楞紙規格	Corrugated board	mm ≤4	≤4	≤4	≤4	≤4	≤4
最大工作壓力	Max. cutting force I	t 150	320	550	550	550	450
最高模切速度	Max. die-cutting speed	S/H 7500	7500	6000	6000	6000	6500
最高燙金速度	Max. stamping speed	S/H 7500	6500	6000	\	\	5000
最大全息及鐳射燙印速度	Max. hologram speed	S/H 5500	5500	5500	\	\	5000
牙排精度	Gripper Precision	mm ±0.075	±0.075	±0.075	±0.075	±0.075	±0.075
輸紙堆高度(含托盤)	Feeder pile height (incl. pallet)	mm 1300	1600	1600	1600	1600	1600
收紙堆高度(含托盤)	Delivery pile height (incl. pallet)	mm 1050	1350	1350	1350	1350	1350
加熱區域	Zones individually controlled	12溫區	20溫區	20溫區	20溫區	20溫區	16溫區
加熱溫度	Temperature	C 30-200	30-200	30-200	30-200	30-200	30-200
最大箔卷直徑	Max. Foil reel diameter	mm φ250	φ250	φ250	\	\	φ300
鋁箔紙芯直徑	Aluminum foil paper core straight warp	inch/mm 25.4/76.2	25.4/76.2	25.4/76.2	\	\	25.4/76.2
主電機功率	Main motor power	kw 7.5	11	15	15	15	15
整機功率	Total power	kw 35	46	46	35	35	53
電壓	Voltage	V 380±5% 50HZ	380±5% 50HZ	380±5% 50HZ	380±5% 50HZ	380±5% 50HZ	380±5% 50HZ
電線粗細	Cable	mm ² 16	16	16	16	16	16
壓縮空氣	Compressed air	bar 6-8	6-8	6-8	6-8	6-8	6-8
用氣量	Air flow	L/Min 550	600	600	200	200	650

安裝數據	INSTALLATION DATA						
型號	Model	C 80 Y	C 106 Y	C 106 DY	C 106 DH	C 106 DHQ	R 130 Y
A 機器外形總長度	Overall machine length	mm 5510	6264	6264	6264	5197	7135
B 機器外形總寬度	Overall machine width	mm 3760	4350	4350	4250	4250	5660
C 機器外形總高度	Overall height of machine	mm 2350	2580	2580	2430	2430	2430
D 送紙機組長度	Feeder length	mm 2170	2425	2425	2425	2425	2800
E 模切機組長度	Die-cutting length	mm 1256	1500	1500	1500	1500	1720
F 燙金/清廢機組長度	Foil / stripping length	mm 915	1067	1067	\	1067	1180
G 收紙機組長度	Delivery unit length	mm 1140	1270	1270	1270	1270	1430
H 機組寬度	Machine width	mm 2050	2350	2250	2250	2250	2460
I 腳踏板寬度	Cat walk way width	mm 1700	2000	2000	2000	2000	3000
J 送紙過道空間	Aisle for paper feeding	mm 2500	3000	3000	3000	3000	3500
K 機器後過道寬	Aisle of machine side	mm 1200	1500	1500	1500	1000	2000
L 出紙過道空間	Aisle for paper delivery	mm 2000	2500	2500	2500	2500	2500
淨重	Net weight	t 14	20.5	20.5	17.5	18.5	30
包裝尺寸長	Packing size length	mm 5700	6500	6500	6500	5290	7500
包裝尺寸寬	Packing size width	mm 2080	2300	2300	2300	2300	2800
包裝尺寸高	Packing size height	mm 2300	2530	2530	2530	2530	2630



C 106 Q / C 106 / C 80 Q / C 80

Automatic die-cutting machine with stripping

清廢自動模切機

該機主要用于印刷包裝工業中的紙盒、紙箱、商標的模切、壓痕和冷壓或凹凸等，特別是各種高級精細的印刷品、如煙盒、酒盒、禮品盒、小家電盒、化妝品盒等，均可以在本機上進行模切凹凸壓痕，以獲得富于立體感，精致美觀的印刷制品。

This machine is mainly used for die-cutting, creasing and cold pressing of paper boxes, cartons and trademarks in the printing and packaging industry, especially for various high-level and fine prints, such as cigarette boxes, wine boxes, gift boxes, and small household appliances boxes. , Cosmetic boxes, etc., can be performed on this machine as well as concave-convex indentation to obtain three-dimensional, exquisite and beautiful printed products.

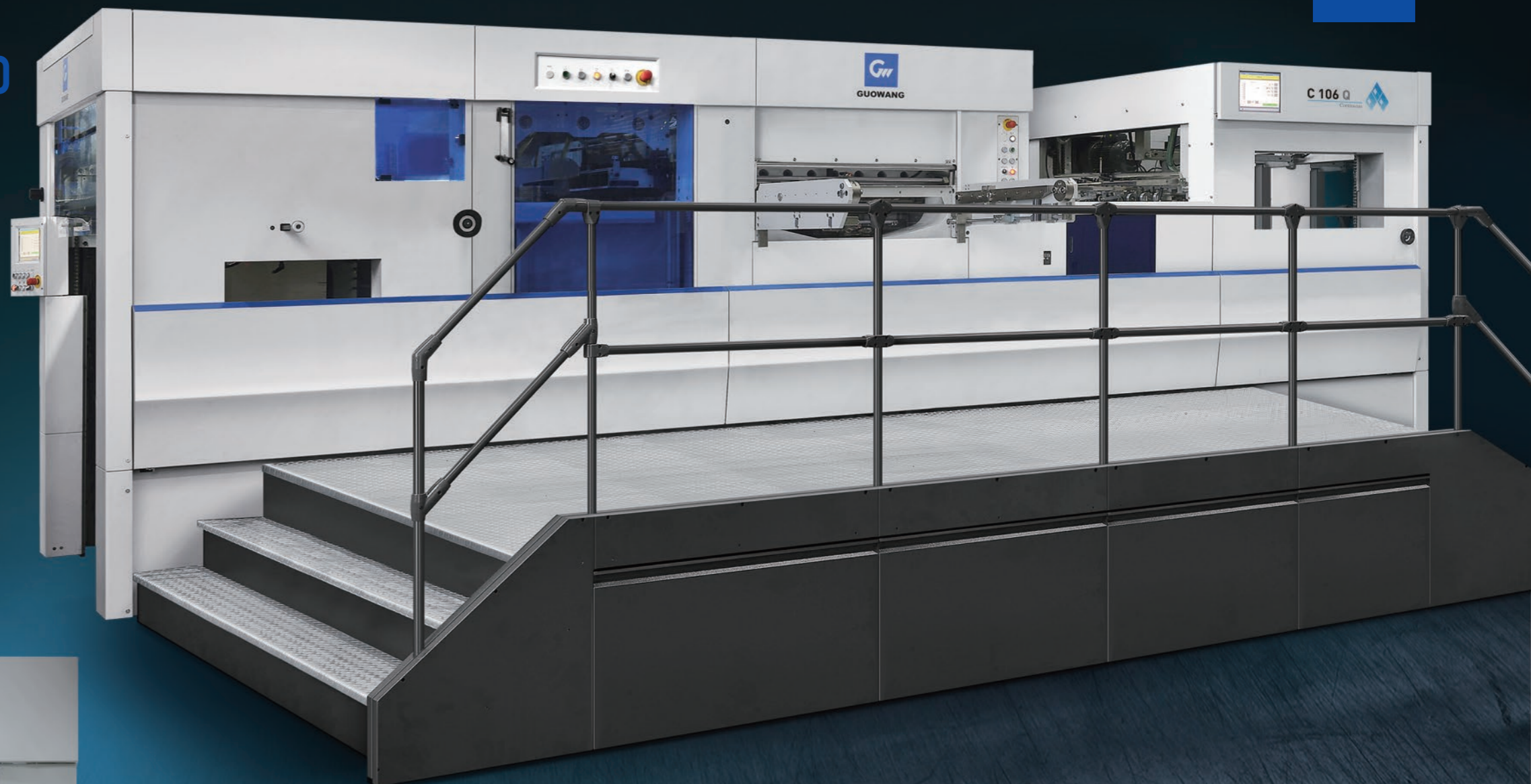

設備特點

CHARACTERISTICS OF THE EQUIPMENT

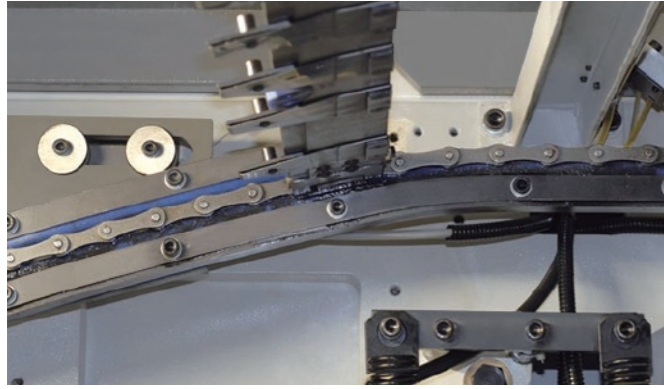

Original Japanese gripper, more durable.

日本原裝高品質牙片，無可比擬的耐用性



The operating system adopts a humanized design, and the feeder components and the delivery components adopt the front and rear dual computer system settings and can control each other. 15 inch and 10.4 inch computers are used

操作系統採用人性的設計飛達部位和收紙部位採用雙電腦系統設定，可相互之間任意控制採用15寸和10.4寸雙電腦系統設定。



Automatic lubrication system
Through the touch scree, you could set the time and quantity to lubricate.

自動潤滑系統
通過觸摸屏可在系統中調節加油間隔以及加油量

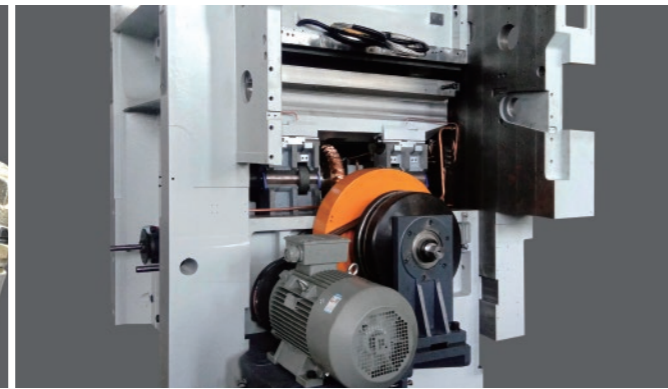

Using ultra-wide beam structure, efficient and stable operation, multi-functional applications for different product requirements, and equipped with 550 tons of strong pressure

採用超寬梁構架，運行高效穩定，多功能應用能適應不同產品需求，並配備550噸大噸位強勁動力，凸現出產品完美立體感。

飛達部分

FEEDER UNIT

1. 高品質制飛達，4吸盤吸紙，4吸盤送紙，確保穩定快速送紙。
2. 預堆紙裝置，飛達不停機，最大堆紙高度1600mm/預堆紙裝置配置軌道使操作人員可準確方便地將紙堆送入飛達。
3. 真空氣泵為德國Becker。
4. 側規可在推拉規間調節以滿足不同紙張需要。
5. 側、前規帶光電對位，可調節靈敏度。
6. 防障礙物進入設備可避免機器損壞/送紙至前規時會減速以使紙張準確定位/日本NITTA傳送帶，速度可調節/傳送板使用德國花紋不銹鋼使紙張順滑快速地傳送。
7. LED操作面板使送過程紙控制更為便捷。

1. High quality feeder with 4 suckers for lifting paper and 4 for forwarding paper to ensure stable and fast paper feeding. Preload device, non-stop feeding, with max pile height up to 1600mm. The preload device is equipped with guiding rails that enable the operators to move the prepared pile to feeder accurately and conveniently.
2. Vacuum pump - German Becker.
3. Side lays can be adjusted between push and pull lays to meet different kinds of paper.
4. Side and front lays are with precise photocells whose sensitivity is adjustable.
5. The anti-obstacle device is adopted to prevent the machine from damage. Paper feeding will be slow down when the paper is about to reach front lays to achieve more accurate paper position. Japanese NITTA convey belt and its speed is adjustable. German made stainless steel is used for convey board to achieve smooth and quick paper transportation.
6. Operation panel with LED display is easier to control the feeding process.

模切部分

DIE-CUTTING UNIT

1. 模切板框和模切下墊板採用 SMC 氣缸鎖定，避免上、下板框鎖定安裝不到位的情況，有效避免人為操作失誤造成的損失。
2. 模切板框採用中心線快速定位的裝版方式，使操作人員在安裝模切板的時候不再需要考慮模切板的左右位置。
3. 模切板同時也可通過使用輔助工具，安裝非標尺寸的模切板，便於客戶實現不同機型模切板之間的通用。

1. The die-cutting plate frame and die-cutting lower backing plate are locked by SMC cylinders to avoid the situation that the upper and lower plate frames are not locked and installed in place, and effectively avoid the loss caused by man-made operation errors.
2. The die-cutting board frame adopts a plate-loading method that quickly locates the center line, so that the operator no longer needs to consider the left and right positions of the die-cutting board when installing the die-cutting board.
3. The die-cutting board can also be installed with non-standard size die-cutting boards through the use of auxiliary tools, which is convenient for customers to realize the common use of die-cutting boards of different models.



安裝地基圖
INSTALLATION FLOOR PLAN

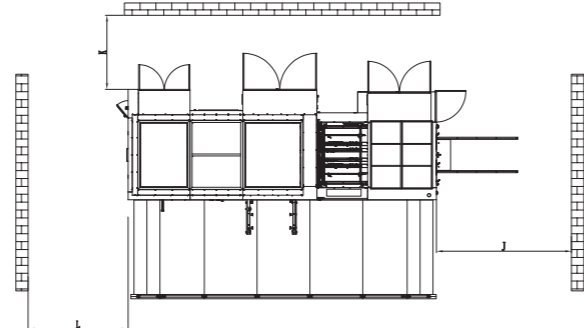
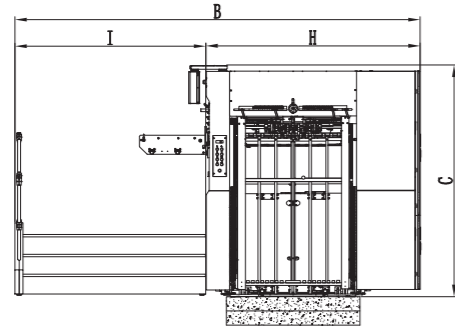
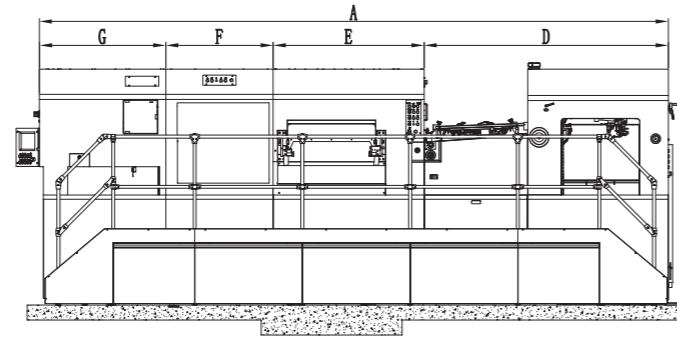

機器參數	SPECIFICATIONS							
型號	Model		C 80	C 80 Q	C 106	C 106 Q	R 130	R 130 Q
最大用紙幅面	Max. sheet size	mm	800x600	800x600	1060x760	1060x760	1300x950	1300x950
最小用紙幅面	Min. sheet size	mm	300x260	300x260	450x370	360x360	550x450	550x450
最大裁切幅面	Max. die-cutting size	mm	785x585	785x585	1045x745	1045x745	1285x935	1285x935
模切版框內尺寸	Die size	mm	840x620	840x620	1100x770	1100x770	1340x960	1340x960
模切鋼板	Cutting plate	mm	3:1	3:1	3:1	3:1	4:1	4:1
鋼絲的高度(模切刀)	Height of die-cutting rule	mm	23.8	23.8	23.8	23.8	23.8	23.8
刀模第一把刀線	First cutting rule	mm	13	13	23	23	13	13
牙片咬口大小	Cripper margin	mm	9-17	9-17	9-17	9-17	9-17	9-17
白卡紙規格	Carton board	g/m ²	90-2000	90-2000	90-2000	90-2000	90-2000	90-2000
卡紙規格	Carton board	mm	0.1-3	0.1-3	0.1-3	0.1-3	0.1-3	0.1-3
瓦楞紙規格	Corrugated board	mm	≤4	≤4	≤4	≤4	≤4	≤4
最大工作壓力	Max. cutting force	t	150	150	300	300	450	450
最高模切速度	Max. die-cutting speed	S/H	7500	7500	7500	7500	6500	6500
精度	Precision	mm	±0.075	±0.075	±0.075	±0.075	±0.075	±0.075
輸紙堆高度(含托盤)	Feeder pile height (incl. pallet)	mm	1300	1300	1600	1600	1600	1600
收紙堆高度(含托盤)	Delivery pile height (incl. pallet)	mm	1050	1050	1350	1350	1350	1350
主電機功率	Main motor power	kw	75	75	11	11	15	15
整機功率	Total power	kw	13	13	17	17	53	53
電壓	Voltage	V	380±5%	380±5%	380±5%	380±5%	380±5%	380±5%
電線粗細	Cable	mm ²	6	6	10	10	10	10
壓縮空氣	Compressed air	bar	6-8	6-8	6-8	6-8	6-8	6-8
用氣量	Air flow	L/Min	180	180	200	200	220	220

安裝數據	INSTALLATION DATA							
型號	Model		C 80	C 80 Q	C 106	C 106 Q	R 130	R 130 Q
A 機器外形總長度	Overall machine length	mm	4595	5510	5055	6045	5955	7135
B 機器外形總寬度	Overall machine width	mm	3620	3620	4250	4250	5460	5460
C 機器外形總高度	Overall height of machine	mm	2150	2150	2430	2430	2430	2430
D 送紙機組長度	Feeder length	mm	2170	2170	2475	2475	2800	2800
E 模切機組長度	Die-cutting length	mm	1256	1256	1330	1330	1720	1720
F 清廢機組長度	stripping length	mm	/	915	/	990	1180	1180
G 收紙機組長度	Delivery unit length	mm	1140	1140	1250	1250	1430	1430
H 機組寬度	Machine width	mm	1920	1920	2250	2250	2460	2460
I 腳踏板寬度	Cat walk way width	mm	1700	1700	2000	2000	3000	3000
J 送紙過道空間	Aisle for paper feeding	mm	2500	2500	3000	3000	3500	3500
K 機器後過道寬	Aisle of machine side	mm	800	1200	1000	1500	1000	2000
L 出紙過道空間	Aisle for paper delivery	mm	2000	2000	2500	2500	2500	2500
淨重	Net weight	t	11.8	13	17	18.5	27	30
包裝尺寸長	Packing size length	mm	4790	5700	5110	6500	6300	7500
包裝尺寸寬	Packing size width	mm	2080	2080	2300	2300	2800	2800
包裝尺寸高	Packing size height	mm	2300	2300	2530	2530	2630	2630

SUPPORT AND SERVICE
支持與服務

服務代表整個公司的形象。
國望在全球範圍內將為您提供一流水準的產品和服務，
保證售前、售中、售後質量統一的一站式服務。
您可以通過電話、郵件、上門等任何形式的聯系方式，
獲得支持與服務——國望堅持以客戶為導向、做到最短反應時間。

GW will offer you the first class service worldwide.
Telephone, E-mail, Visit through
any way you will get one-station service.



全球設有97個代理商

我們為您提供以下售前諮詢服務：
1.針對您目前的現狀提供適當的建議和支持；
2.針對您感興趣的產品進行詳細介紹并提出相應方案；
3.針對您的需求提供定制服務。

97 AGENT/DEALER WORLDWIDE

We could offer:
1. According to the situation, send the advice and suggestion.
2. Make the introduction/offer according to your requirement.
3. Customized service.

全國銷售熱線

Domestic sales hotline

+86 577-58 11116

國外銷售熱線

International sales hotline

+86 021-62 999 507

售後服務熱線

After-sales hotline

400-180-6866



售前諮詢

作為您最好的合作夥伴，
我們會盡力幫您更加成功。
無論是技術升級還是產品優化，
我們義不容辭。

CONSULTATION

As your best partner,
No matter on tech upgrade or products
optimized, definitely we will
help you more successful.



售後服務

快速，高效，精準

SERVICE

Fast, Efficient, Accurate



零配件

完備的庫存
從接到您的需求到派送，
國望會以最快速度的完成。

PARTS

Perfect parts storage.
We will send the parts to you at
fastest once we get your requirement.



技巧&竅門

我們會不定期的為您發送設備使用技巧，
保養事項等有用信息。

SKILL & TIPS

We will send you the using skill &
maintenance information etc.
from time to time.